

(16x) M8x14

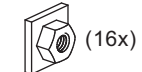

(16x)

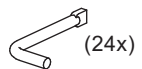

(24x)

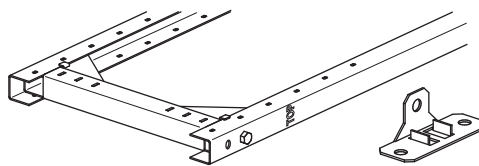

(2x)

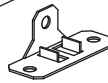

(4x)

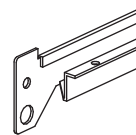

(6x)

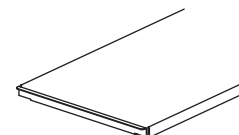

(6x)



(1x)



Megaflex Verbinder Grund 2500

1.

2500

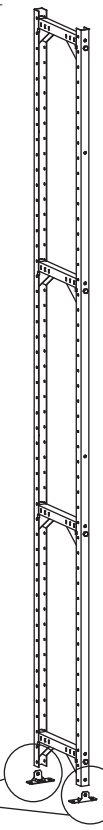
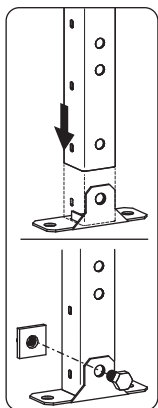

5.

2.

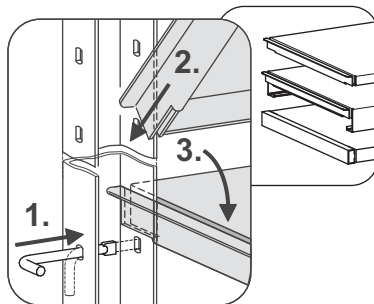

3.

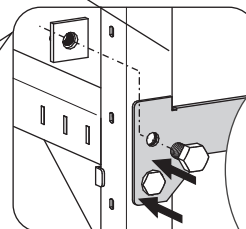
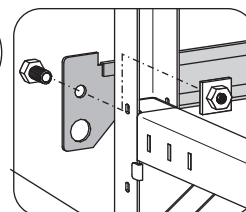

4.

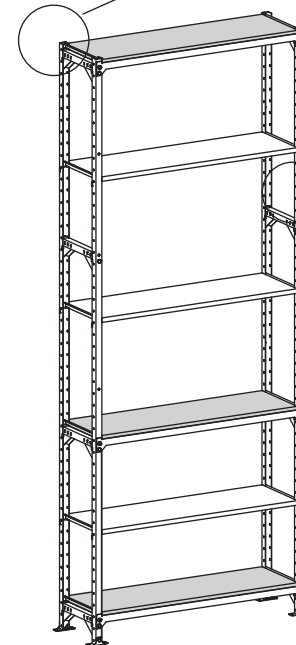
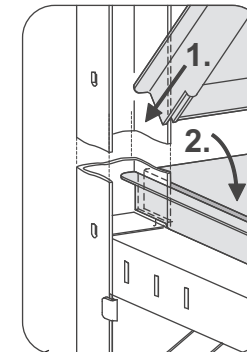

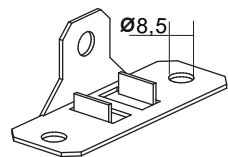
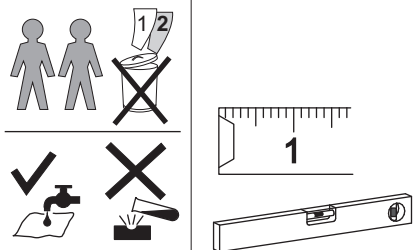

(8x)

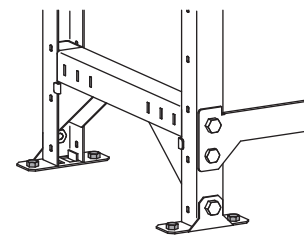
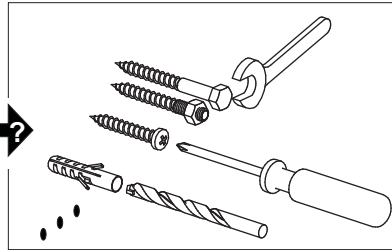
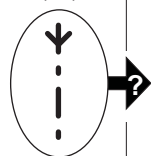

Megaflex Verbinder Grund 2500

5.

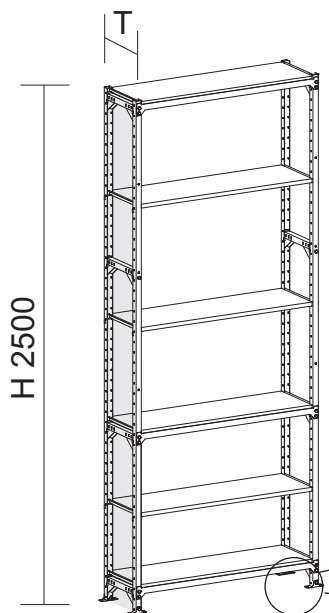

$H:T \geq 5:1$

$T =$
300
400
500

$H:T < 5:1$

$T =$
600
700
800
1000